



Vane Wheel **Flow Sensors FA**



Vortex **Flow Sensors VA**



Thermal **Flow Sensors TA**

Measuring technology for flow rate, mass flow rate and flow velocity



Summary of Contents

03 | Company Philosophy

04 | Applications

06 | Principles of Measurement
and Choice of Sensor

08 | Individual Solutions

09 | Handheld flowtherm NT

10 | Calibration Facilities

12 | Research and Development

13 | Höntzsch Worldwide



Quality is the key
to success...

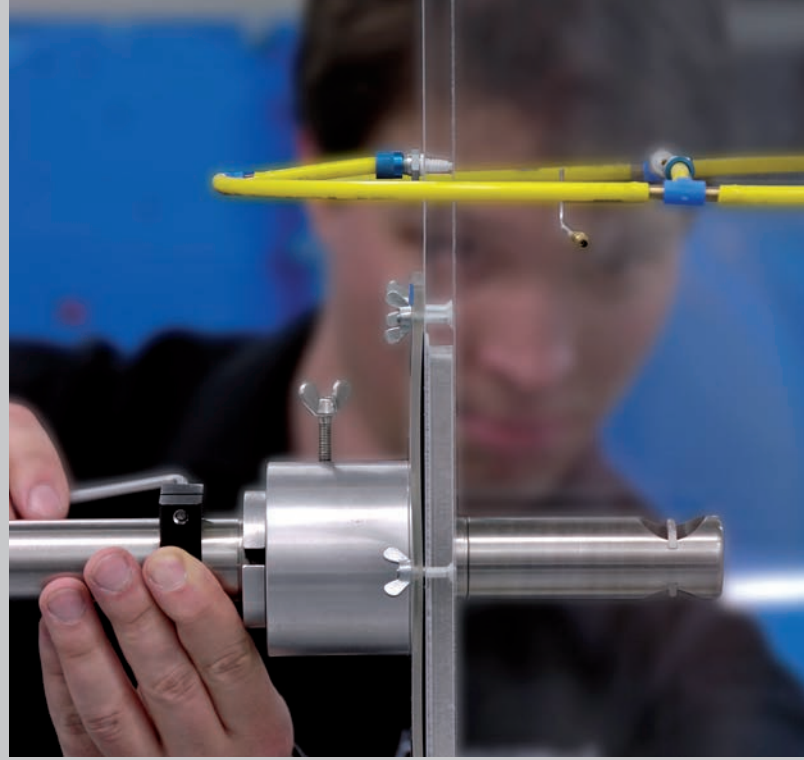

... and therefore we have made it our goal to realise your demands on our products and services for maximum benefit!

Since 1976 we have been designing and developing, manufacturing and distributing innovative products in the flow measuring technology sector. Our focus here is on achieving a high standard of quality and precision measurement technology, with always one goal in mind – to solve your measuring tasks or problems as efficiently and effectively as possible. Certifications, accreditations and standards such as ATEX, SIL, DGRL, CSA, BImSchV and ISO 9001 emphasise this.

We have expert knowledge in solving a whole range of measuring requirements - fixed or portable - in all industrial sectors, for example in measuring

- the distribution of compressed air and natural gas in networks
- process gases and flare gases in the chemical industry

- the rate of biogas flow in biogas and sewage treatment plants as well as landfill sites
- flow and flow rate of gases and liquids in automotive research
- the laminar flow in clean rooms and pharmaceutical machines

Quality materials such as aluminium, stainless steel, Hastelloy, titanium and tantalum ensure a long life cycle for our sensors, even in the most challenging operating conditions.

The strong points of our sensors become evident in applications with extreme demands, for example, in potentially explosive atmospheres, in aggressive mediums, in gases with temperatures up to 550 °C, high flow velocities up to 200 m/s or in pipe flows with changing gas compositions or direction of flow.

We would be only too pleased to solve your measuring problems: challenge us! Put us to the test!

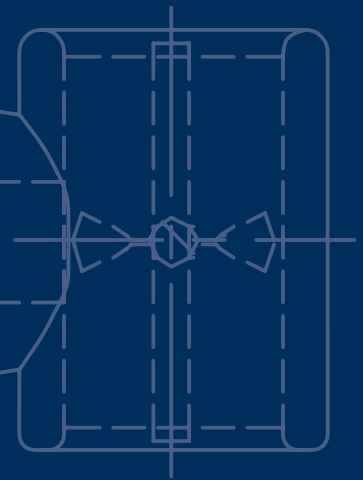

Thomas Itte

Thomas Itte

Jürgen Lempp

Jürgen Lempp

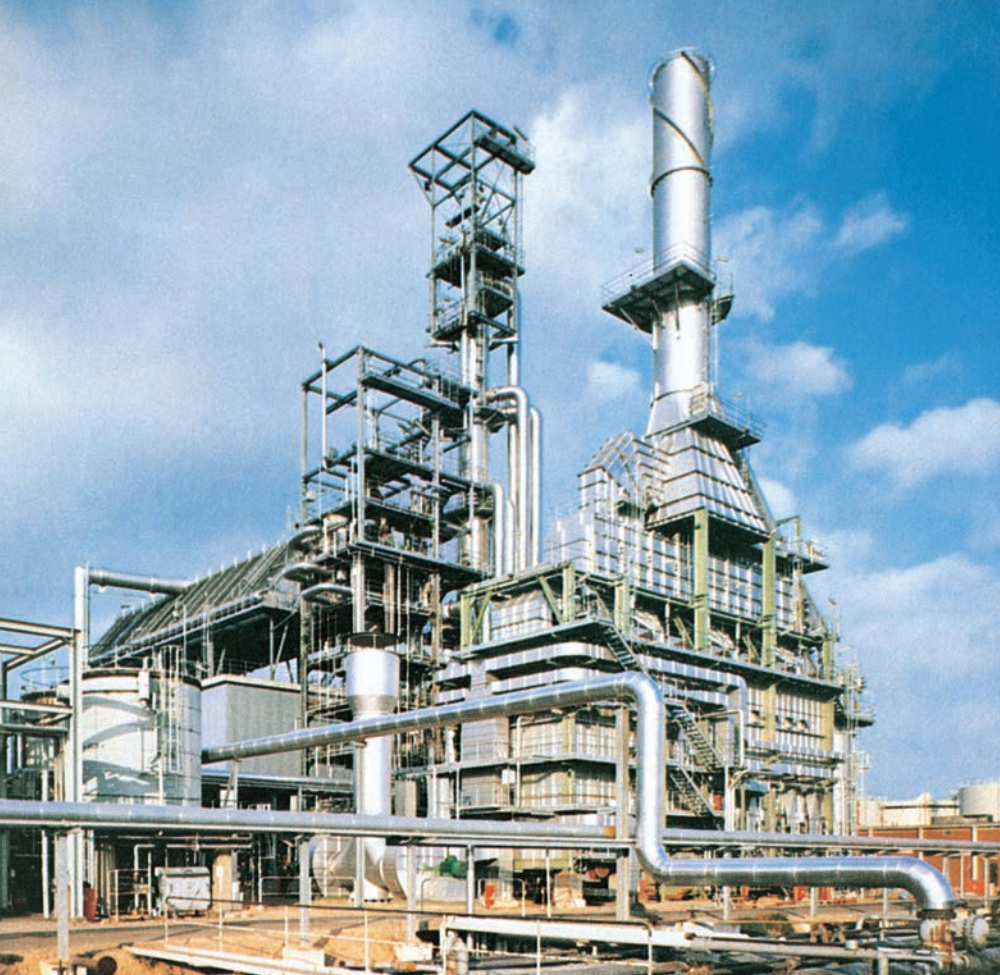

Clean-room Technology

To ensure air quality in clean rooms, laminar flow must be generated. This can only succeed when the flow velocity is constantly controlled in a very small range. Thermal sensors TA10 with integrated transducer are tailor-made for such measurements. Vane wheel flow sensors ZS30 are the ideal solution for laminar flow in sterilising tunnels at temperatures up to 350 °C.

Chemical and Petrochemical Industries

Höntzsch measuring instruments with ATEX, CSA and SIL certification ensure a high degree of plant safety, product quality and efficient use of energy. Their success has been proved, both in fixed and portable applications, in aggressive and explosive process gases, flare gases and emissions.



Water Management

The air input in aeration basins is extremely cost-intensive. Therefore, by optimising the compressor control, based on an exact flow measurement with Höntzsch TA or VA sensors, substantial savings potential may be generated. Our maintenance-free, explosion-proof vortex sensors VA are particularly suited for monitoring the amount of gas produced in digestion towers.



Pharmaceutical Industry

The implementation of quality assurance systems according to Good Manufacturing Practice (GMP) guarantees that safety, quality and effectiveness are ensured for every stage of production. Höntzsch sensors contribute to this: be it in design and development, manufacture and production, packaging or usability testing of pharmaceutical products.

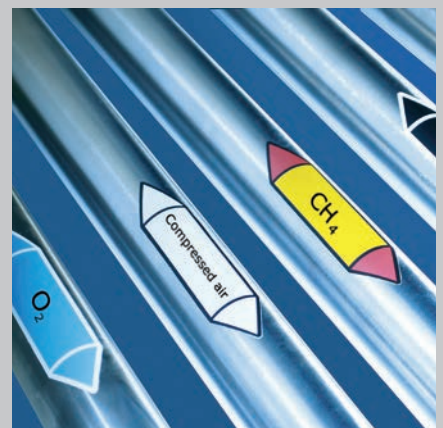

Gas Utilities

Compressed air, natural gas and other gas mediums are costly sources of energy. Substantial savings can be made by early detection and elimination of gas leaks and by controlling the performance of compressors. Thermal flow sensors TA have no moving parts, are accurate, robust and maintenance-free and with their turndown ratio of 1 : 1000, flow rates from leakage flow to the maximum gas withdrawal can be measured with reliability.



Aerodynamics

Vane wheel flow sensors TS are, in the most adverse of oncoming flow conditions, still able to give precise value readings. In wind tunnel or road tests the flow field can be quickly determined even around complex structures. Even reverse flow zones on vehicle radiators can be measured without difficulty, thanks to the ability of +/-directional flow sensing.



Aerospace

Whether measuring the air flow around actuators in the wings of commercial aircraft, cabin air flow or the weight-optimised flow through measurement of life support systems in the field of crewed space flights: Höntzsch has the user-specific solution!



Engine Test Bench Technology

Ever decreasing emission limits and the best possible use of fuel savings potential, make a more and more accurate logging of all relevant parameters in test bench measurements necessary. Höntzsch sensors provide here long-term stable and accurate values when measuring the mass flow rate of engine intake air or exhaust emission.



Customised solutions for maximum precision and economic efficiency



Nuclear Engineering

In the field of nuclear engineering the highest safety requirements apply. Höntzsch sensors of all three measuring principles are used in controlling numerous system parameters and deliver measuring signals, which are indispensable for the assessment of the operating conditions.



Landfill Technology

Höntzsch explosion-proof thermal flow sensors TA have proved their worth both in fixed and portable measurement of the amount of landfill gas. These sensors also reliably measure the diminishing gas flow rates in finished landfill sites.



Biogas Generation

Höntzsch ex-protected vortex sensors VA, which produce only a slight pressure loss, are to be recommended for measuring the flow rate of biogas. The results are reliable, also with a marginal rate of flow, even if the gas composition changes, is wet or charged with particles.



Cement Industry

Whether in burner management systems of rotary furnaces or filtering of waste gases: wherever measuring in dust-laden and hot gases is a necessity, vortex sensors VA are the perfect choice.

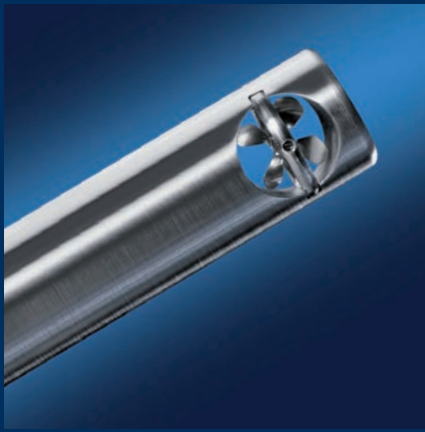

Vane Wheel Flow Sensor FA
as insertion probe

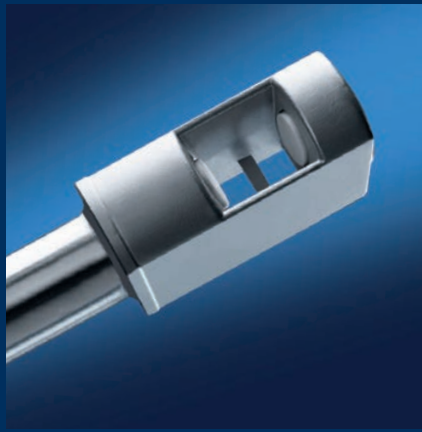

Vortex Flow Sensor VA
as insertion probe

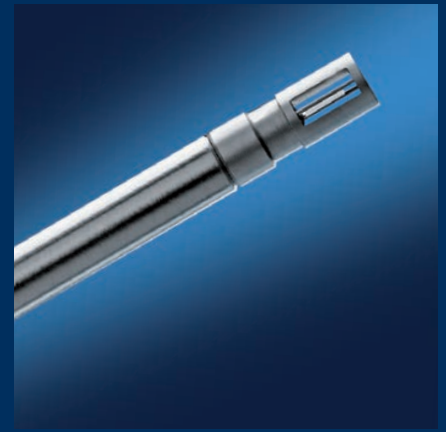

Thermal Flow Sensor TA
as insertion probe

Quality, Reliability and Precision: Höntzsch Flow Sensors



Vane Wheel Flow Sensors FA

Measurement is based on a vane wheel rotating at a speed proportional to the flow velocity of the fluid which surrounds it. The rotational speed is to a great extent independent of density, pressure and temperature of the medium. Sensing of the vane wheel rotation takes place without a braking effect on the vane wheel. Soiling does not influence the impulse recognition. Additional sensing of the \pm direction of flow is possible. The advantage of the FA sensors is its wide range of application. Whether in liquid or gaseous mediums, at high temperatures or pressures, this sensor supplies reliable values.

Designs:

- Insertion probe with probe diameter from 15 mm
- Measuring tube inside diameter from 9,7 mm
- Combi probes for flow and temperature

FA

- for application in **air / gases** and **water / liquids**
- in air / gases measuring ranges **0.2...120 m/s**
- for use at working temperatures **up to +550 °C**
- **corrosion resistant**
- low pressure drop
- \pm directional sensing of flow
- Profibus
- for applications in areas



Vortex Flow Sensors VA

Derived from the Karman phenomenon of vortex shedding, the principle of measurement is based on vortices building up periodically on a strut in the sensor head. The shedding frequency is detected with the help of an ultrasonic field. The flow velocity and volume flow of air / gases are determined in this way. The measuring result is to a great extent independent of pressure, temperature, kinematic viscosity or composition of the gas. The great advantage of ultrasonic scanning of the flow vortex is the very slight initial measurable flow rate of just 0,5 m/s and the extensive measuring range!

Designs:

- Insertion probe for installation in pipelines from Di 80 mm
- Measuring tubes with inside diameter from Di 25 mm
- Combi probes for flow and temperature

VA

- also suitable for use in **condensate and particle-laden, aggressive gases**
- sensor with no moving parts
- for measurements in accordance with German TA Luft **13. und 17. BImSchV**
- SIL certification
- time constant 120 ms
- low pressure drop
- for applications in areas



Thermal Flow Sensors TA

The measuring method is based on a mechanically protected built-in sensor element being electrically heated. The standard flow velocity, standard volume flow and mass flow of the gas are determined by the resulting heat flow in the ambient gas. Working temperature and pressure of the medium do not affect the measuring result. The sensor causes only a very slight pressure drop and is especially made for measuring consumption of natural gas, compressed air and other gases. The sensor makes the detection of leakage volume flows and maximum flow rates possible.

Designs:

- Insertion probe for installation in pipelines with inside diameter from Di 25 mm
- Measuring tubes with inside diameter from Di 8 mm

TA

- for use in gases such as air, compressed air, nitrogen, natural gas, methane, deposit gas, argon, helium, propane, butane, CO₂, SF₆
- **gas mass flow-proportional measuring**
- standard flow velocity **0.08 m/s to 200 m/s**, standard volume flow up to **0.04 m³/h**
- time constant of only 1 s
- for applications in areas

Sensor type			
	Vane wheel FA	Vortex VA	Thermal TA
measurable variable	actual flow	actual flow	standard flow, mass flow
measuring ranges gases	0.2...120 m/s	0.5...80 m/s	0.08...200 m/s
measuring ranges liquids	0.01...10 m/s	-	-
temperature ranges	-40...+550 °C	-25...+250 °C	-10...+240 °C
pressure ranges	up to 10bar, 1MPa	up to 10bar, 1MPa	up to 40bar, 4MPa
material sensor housing options	aluminium / stainless steel / titanium	stainless steel / hastelloy / titanium / tantalum	stainless steel
 -version optional	Ex ia Ex d	Ex ia Ex d	Ex ia Ex d
Applications			
clean and / or particle-free gases	fixed / temp.	fixed / temp.	fixed / temp.
particle-laden gases	temp.	fixed / temp.	-
gases liable to condensation	temp.	fixed / temp.	-
consumption measurement of compressed air, N ₂ , O ₂ , CO ₂ , Ar, He, Xe, Kr, Ne, SF ₆	*	*	fixed / temp.
consumption measurement of natural gas, CH ₄ , H ₂ , C ₄ H ₁₀ , C ₃ H ₈ , C ₂ H ₂	*	*	fixed / temp.
process gases	fixed / temp.	fixed / temp.	fixed / temp.
direct air / gas mass flow measurement	*	*	fixed / temp.
flow measurement in air conditioning and ventilation systems	fixed / temp.	fixed / temp.	fixed / temp.
flow measurement in  area Category 1G, 1D (Zone 0, 20)	fixed	fixed	fixed
flow measurement in  area Category 2G (Zone 1)	fixed / temp.	fixed	fixed / temp.
flow measurement in  area Category 3G, 3D (Zone 2, 22) / 3G (Zone 2)	fixed / temp.	fixed / temp.	fixed / temp.
biogas quantity measurement	temp.	fixed	-
landfill gas quantity measurement	fixed / temp.	fixed	fixed / temp.
measuring exhaust gases up to +550 °C	fixed / temp.	-	-
measuring exhaust emissions up to 180 °C in accordance with TA Luft, 13.+17. BImSchV	-	fixed	-
flow measurement in clean rooms, in laminar flow	fixed / temp.	-	fixed / temp.
flow rate measurement in superheated steam	-	fixed / temp.	-
flow measurement with ± direction sensing	fixed / temp.	fixed	-
measuring in relatively clean liquids resembling water	fixed / temp.	-	-
flow measurement in water conduit systems for example for determining leakages	fixed / temp.	-	-
control measurement in running waters	temp.	-	-
measuring in pre-clarified sewage water	temp.	-	-
fuel flow measurement	fixed / temp.	-	-

fixed = long-term measurement

temp. = **temporary**, short-term or portable measurement

***** = where required, in conjunction with pressure and temperature measurement

Vane Wheel Flow Sensor FA
as measuring tube



Vortex Flow Sensor VA
as measuring tube



Thermal Flow Sensor TA
as measuring tube





Modular technology for specific solutions – whether for converting your measured values or isolation and supply for intrinsically safe circuits.

Transducers, system units for installation in control cabinets or outdoors.

Are you looking for individual solutions to your problems?

Thanks to our considerable in-house production depth and application know-how, we are able to satisfy almost all individual requirements by finding the optimal solution to suit your needs.

3D construction and an extensive portfolio of modular applicable components make cost effective customer-specified solutions possible.

Why not draw on almost 4 decades of experience in flow measuring technology?



ExactFlow II in a customer-specific application with multiphase flow straightener.
3D drawings for spatial overview.

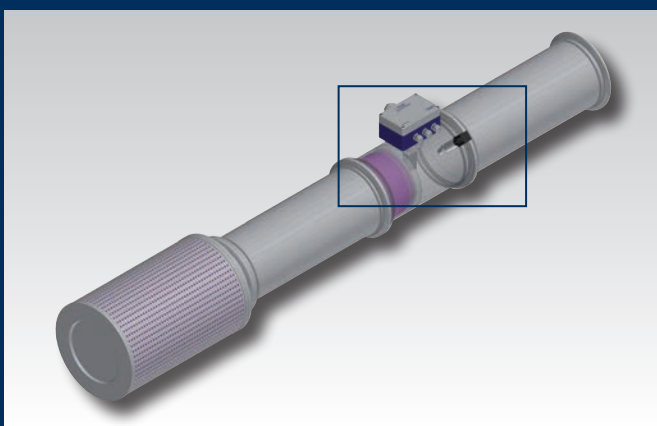

ExactFlow II
For precise determination of flow rate and mass flow.





The multifunctional handheld flowtherm NT: One device for all measurements and sensors

Building on almost 40 years' experience in design and development of portable flow measuring devices, the new generation leaves nothing more to be desired.

With the flowtherm NT all 3 sensor families can be used with just the one device.

In addition, almost any sensor for measuring physical values can be connected via the analog input. Scale and physical unit are user-definable.

Precise measurement of temperature is possible using the input for Pt100 resistance thermometer.

The data logger has a capacity for up to 40000 data sets.

A USB port is available for configuration and data readout.

100 user profiles for sensors and measuring points can be stored.

2 analog outputs broaden the range of possible applications.

The flowtherm NT has ATEX accreditation for use in  area category 3G.

Measurable variables

- flow velocity
- flow rate
- standard flow rate
- mass flow
- temperature
- other freely definable variables such as pressure, humidity, etc.

HLOG II

This software allows easy transfer, display and export of data from the flowtherm NT to a PC as well as easy configuration of the unit on the PC. The data is well presented both graphically and in table form.





Volume flow calibration installation, pressure up to 10 bar, 1 MPa, nominal value up to DN200



High temperature wind tunnel, 0.1 ... 80 m/s, +20 °C... +400 °C



Water calibration installation, nominal values up to DN150

“Measure the measurable and make the immeasurable also measurable.” *(Galileo Galilei)*

Höntzsch Calibration Centre

In order to fulfil the ever-increasing demands on precision and the application spectrum of our flow sensors, it is necessary to further develop our calibration techniques to the same extent as we do our other products. We calibrate flow velocity and flow rate sensors using seven test stands, equipped with the most up-to-date technology.

We guarantee that equipment is calibrated by us in accordance with a certified quality assurance system **DIN EN ISO 9001**. The accuracy of the references is based on **PTB** (German national metrology institute) standards.





To believe in the future is to believe in progress.

We are working continuously on new products and solutions. State-of-the-art technology is of great importance to our experts in the field of appliance design, electronics and flow technology and they also ensure that all national and international directives and laws are complied with. In this connection we use only the most modern of tools for developing our products.

Whether working on our own, in cooperation with our customers, with renowned research and development agencies and institutes or partners in industry and suppliers, it is always our aim to further develop measuring equipment which will fulfil the expectations of our customers in the future.

Wind tunnel with laser Doppler anemometer reference 0.15 ... 70 m/s

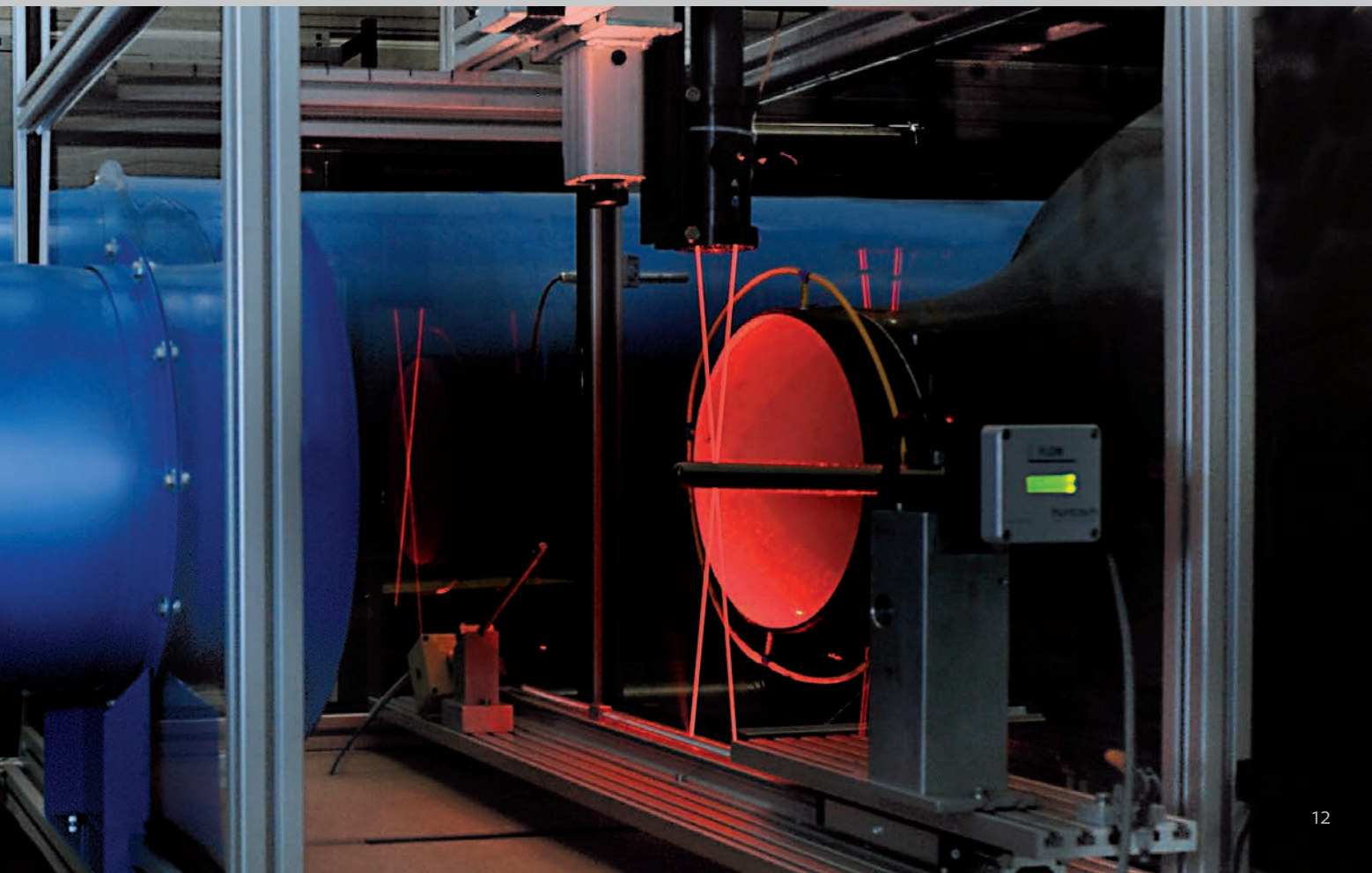



Application Examples

Worldwide market: Höntzsch measuring technology

The variety of applications and the reliability of our flow velocity and flow rate sensors make the marketing of our products around the world possible.

All over the world our measuring equipment guarantees process and site safety and security. The trust and satisfaction of our customers is proof enough!

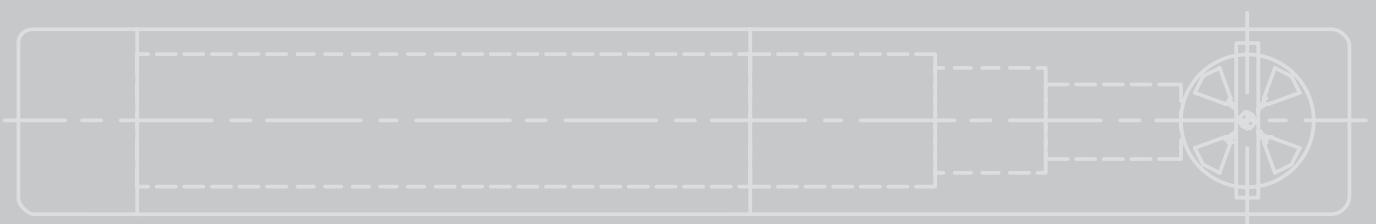

Subject to alteration. 6/12

Höntzsch GmbH

Gottlieb-Daimler-Str. 37, 71334 Waiblingen, Germany

Phone +49 7151/17 16-0, Fax +49 7151/58402

www.hoentzsch.com, info@hoentzsch.com